

Name	Diederick 275x375+375_28		
Zeichnung/Drawing	3D		
Profil/Profile	2.8x11.4	Datum/Date	25.10.2018

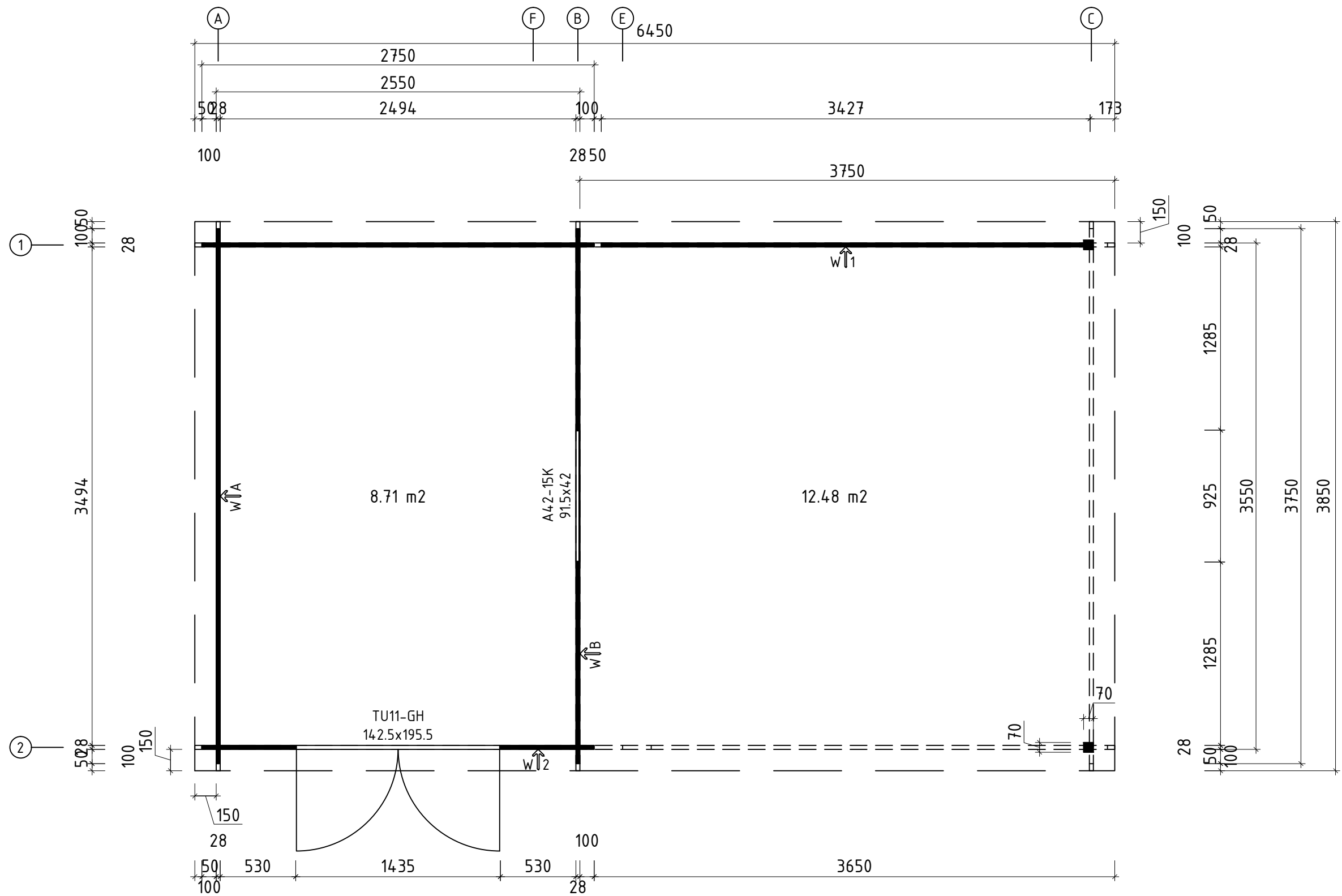

Name	Diederick 275x375+375_28		
Zeichnung/Drawing	Grundplan, Plan		
Profil/Profile	2.8x11.4	Datum/Date	25.10.2018

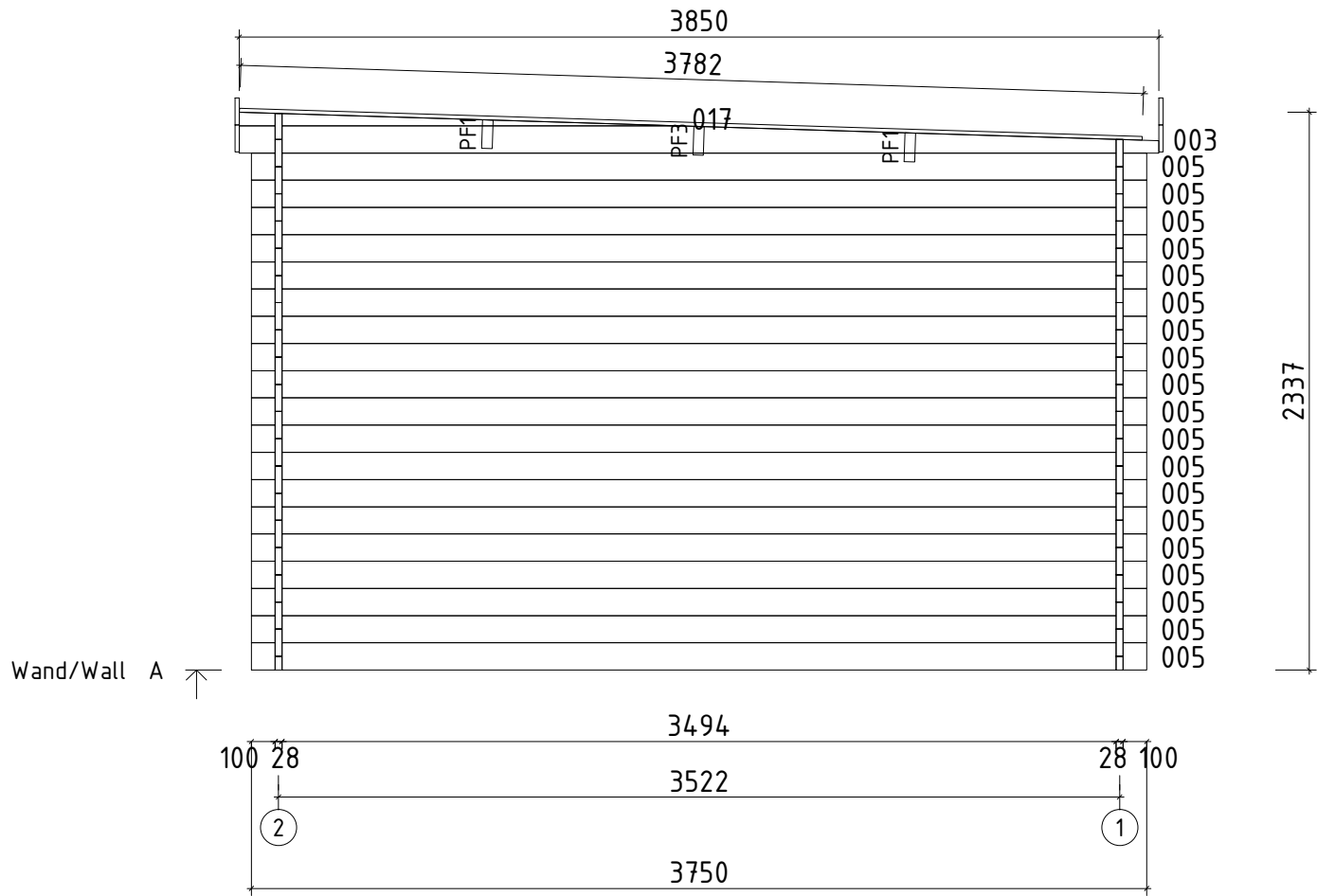

Name	Diederick 275x375+375_28		
Zeichnung/Drawing	WAND/WALL A		
Profil/Profile	2.8x11.4	Datum/Date	25.10.2018

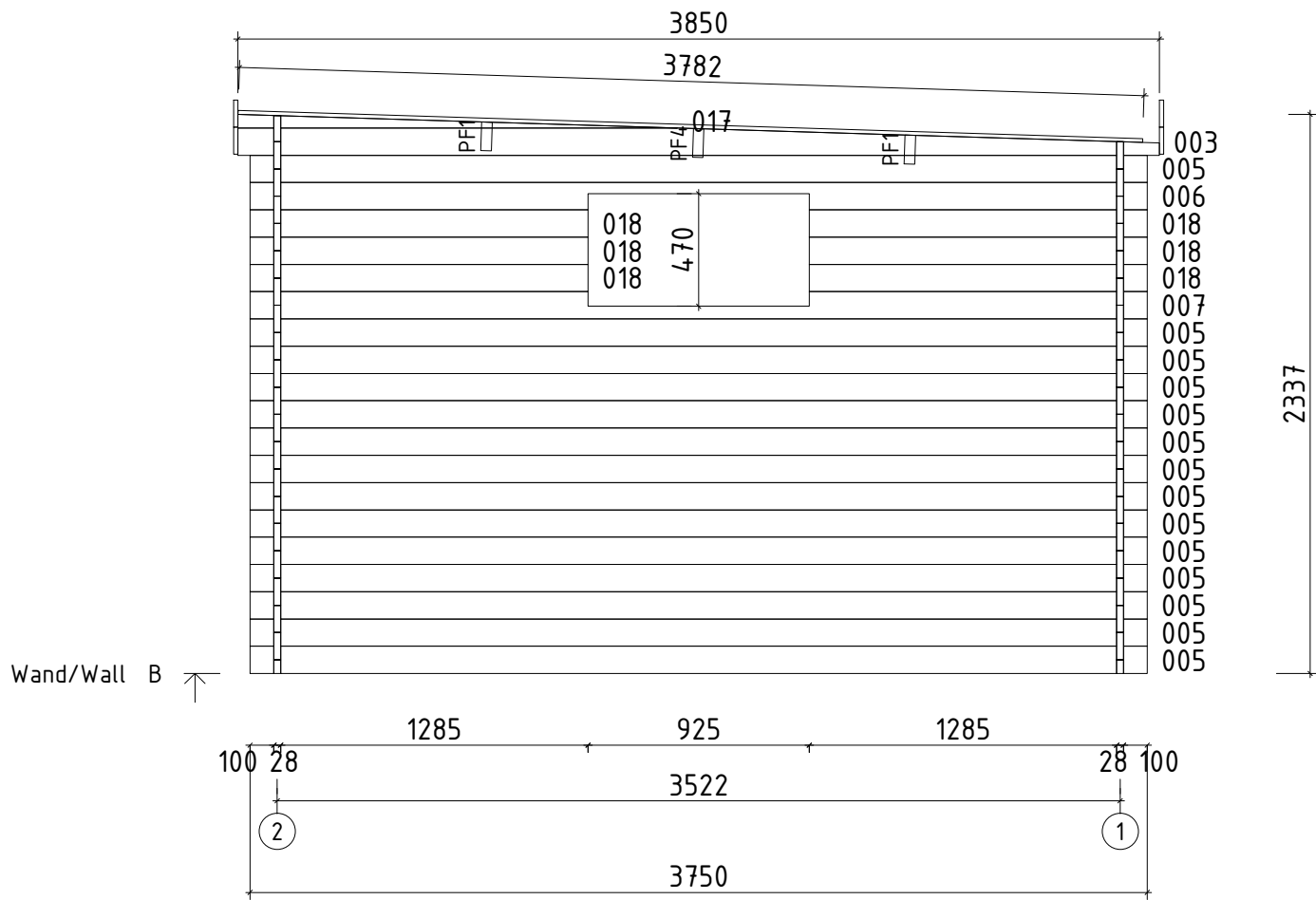

Name	Diederick 275x375+375_28		
Zeichnung/Drawing	WAND/WALL B		
Profil/Profile	2.8x11.4	Datum/Date	25.10.2018

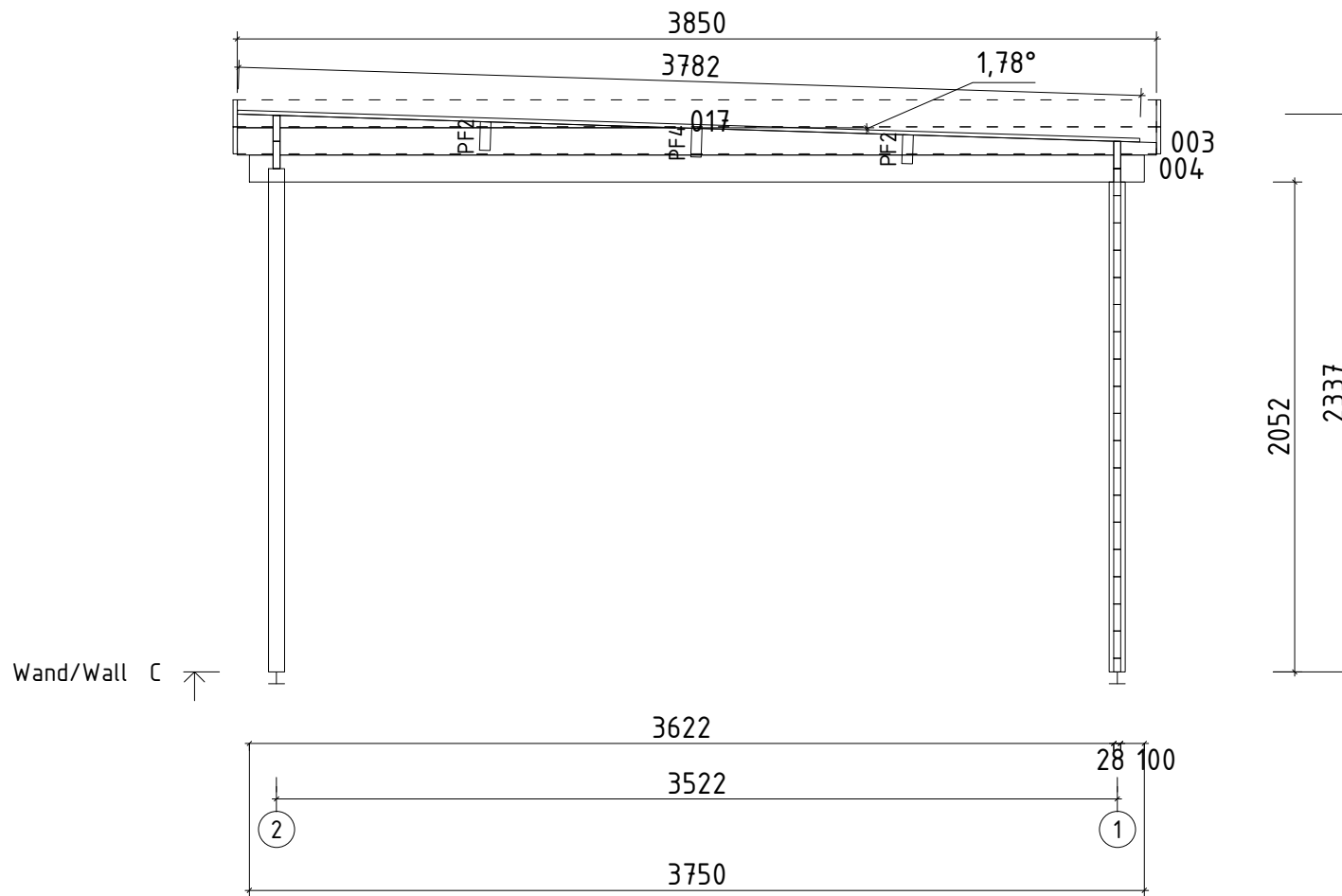



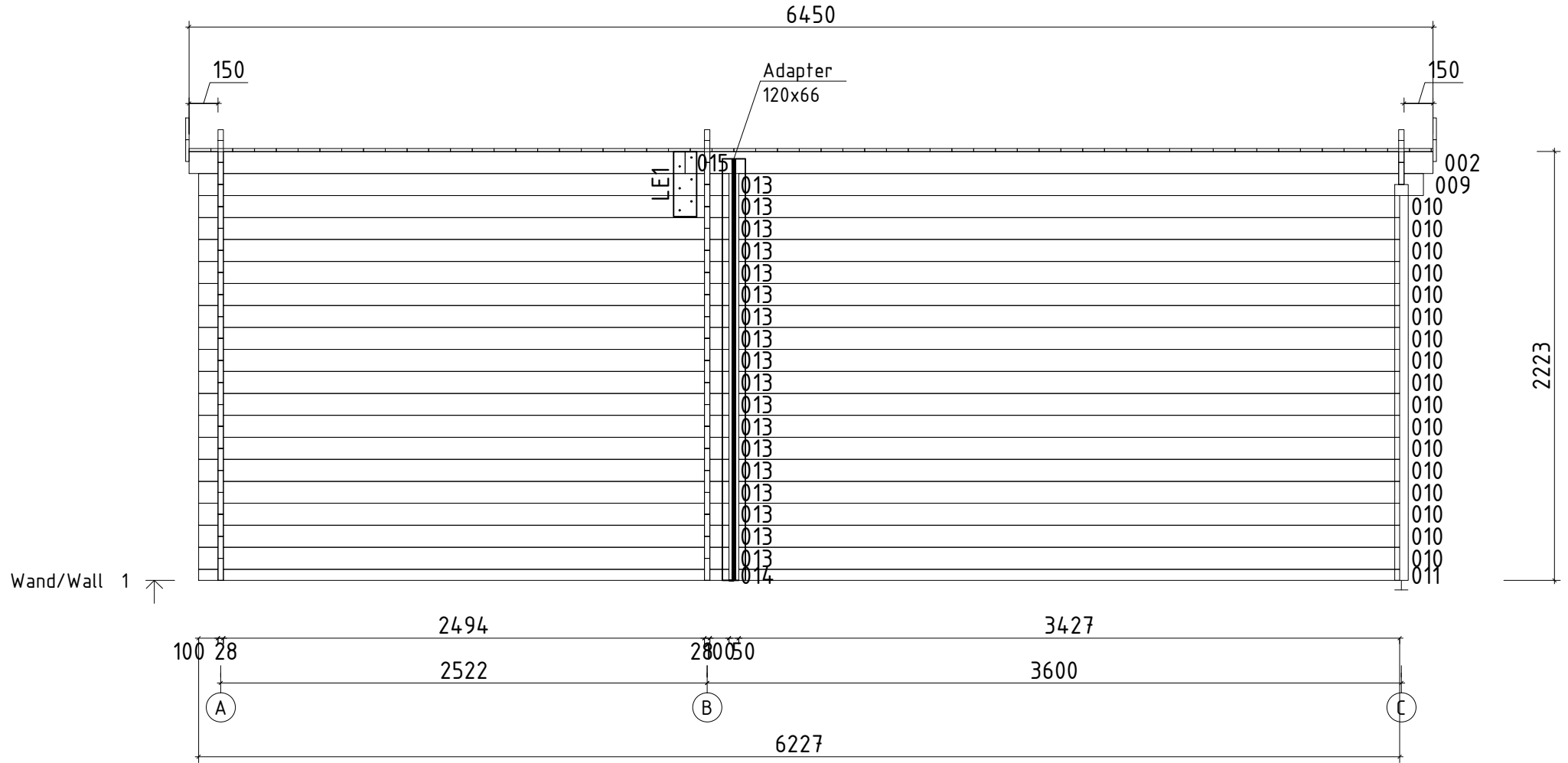

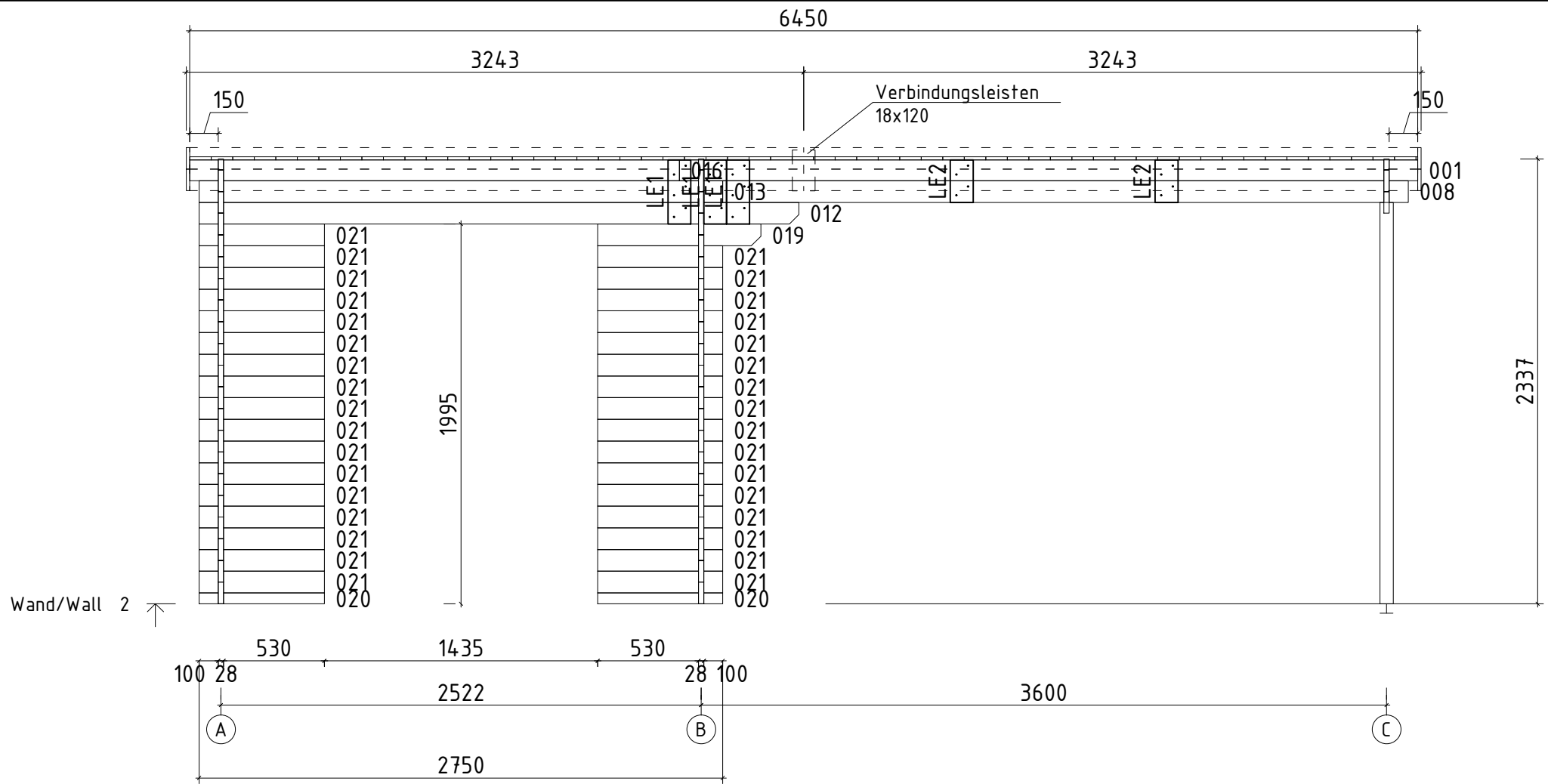

Name	Diederick 275x375+375_28		
Zeichnung/Drawing	WAND/WALL C		
Profil/Profile	2.8x11.4	Datum/Date	25.10.2018

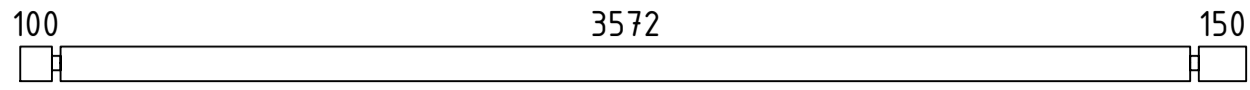
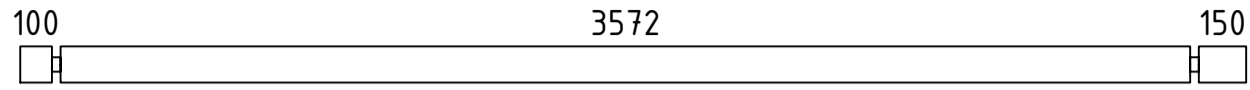
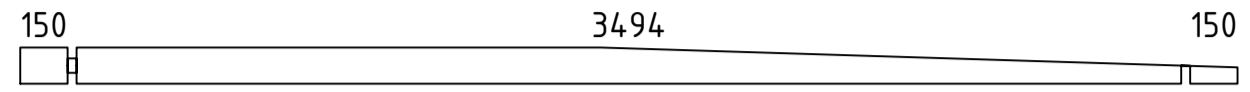
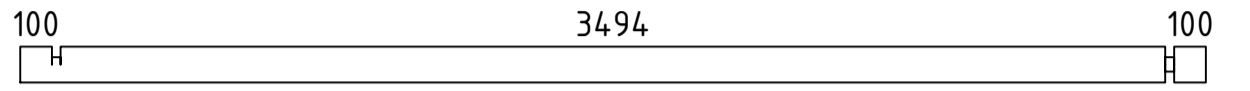
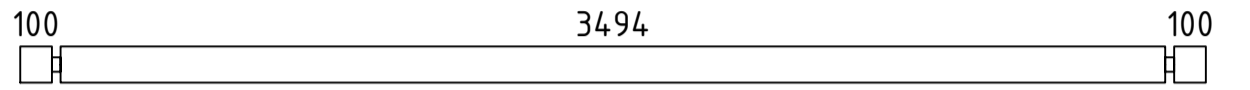
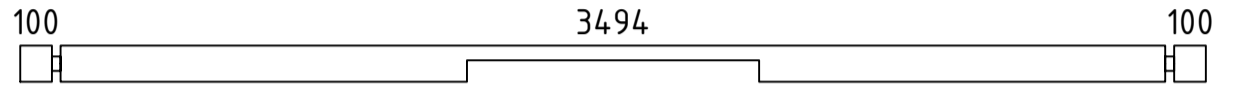
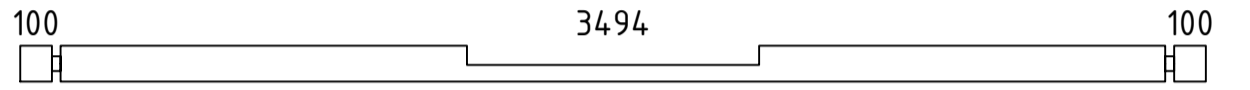
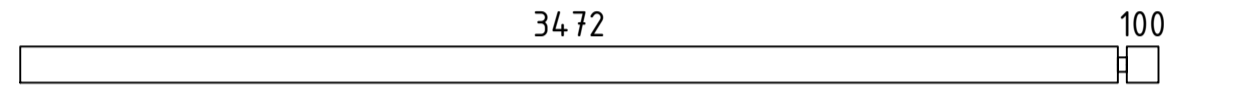
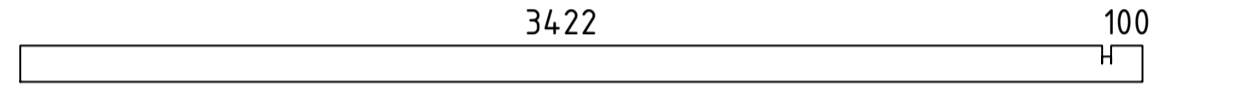
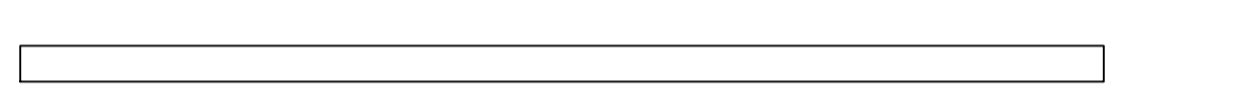
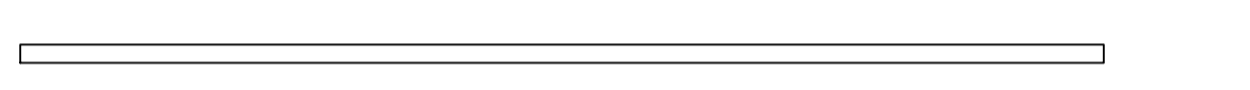
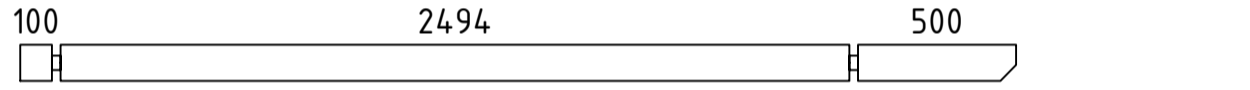
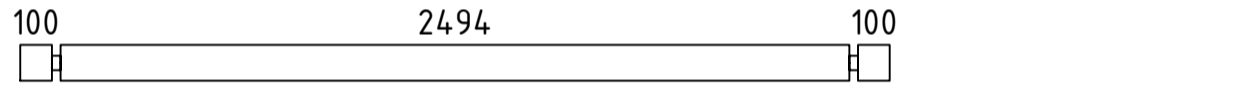
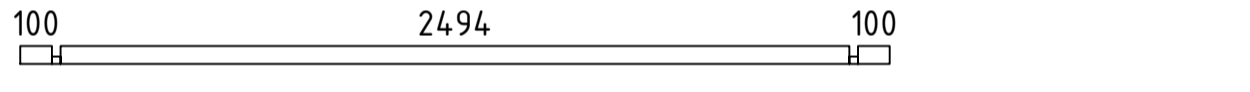
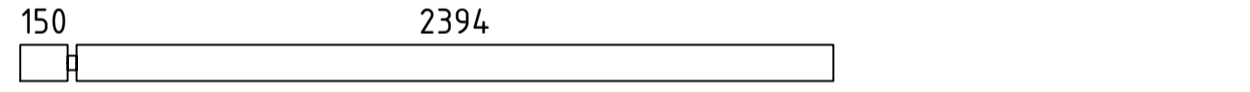
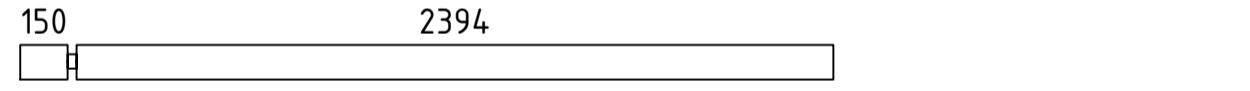
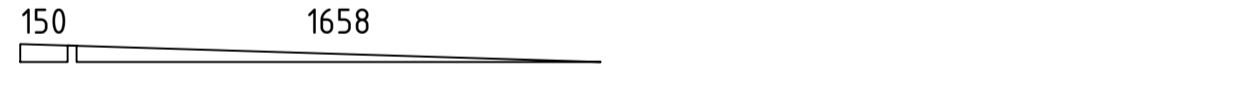

Name	Diederick 275x375+375_28		
Zeichnung/Drawing	WAND/WALL 1		
Profil/Profile	2.8x11.4	Datum/Date	25.10.2018

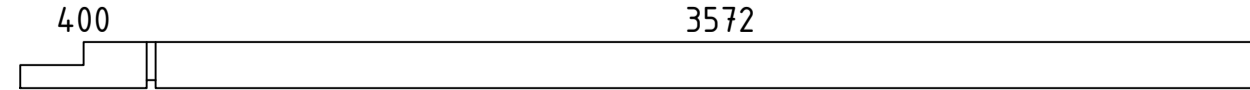
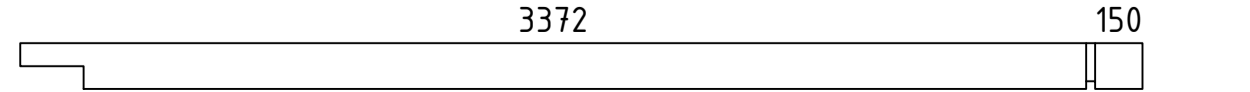

Name	Diederick 275x375+375_28		
Zeichnung/Drawing	WAND/WALL 2		
Profil/Profile	2.8x11.4	Datum/Date	25.10.2018

Pos	Teieliste/Specification Diederick 275x375+375_28	Stck. Pcs.	Profil Profile (mm)	Länge Length (mm)
001		1	28x109	3878
002		1	28x114	3878
003		3	28x114	3850
004		1	28x114	3750
005		33	28x114	3750
006		1	28x114	3750
007		1	28x114	3750
008		1	28x114	3600
009		1	28x114	3550
010		17	28x114	3427
011		1	28x57	3427
012		1	28x114	3150
013		19	28x114	2750
014		1	28x57	2750
015		1	28x114	2572
016		1	28x109	2572
017		3	28x57	1836
018		6	28x114	1413
019		1	28x114	858
020		2	28x57	658
021		33	28x114	658
LE1	LEISTE - LATH 	4	120x18	335
LE2	LEISTE - LATH 	2	120x18	220
PF4	PFETTEN - PURLIN 	1	44x145	4178
PF2	PFETTEN - PURLIN 	2	44x145	3550

Pos	Teileliste/Specification Diederick 275x375+375_28		Stck. Pcs.	Profil Profile (mm)	Länge Length (mm)
PF1			2	44x145	3100
PF3			1	44x145	2472
	DACHBRETTEN - ROOF BOARDS		58+1	113x16	3780
BB-1	DACHBLENDEN- Blendenbretter - PARAPET boards		4	18x113	3850
BB-2	DACHBLENDEN- Blendenbretter - PARAPET boards		8	18x113	3243
VL-1	DACHBLENDEN- Verbindungsleisten - PARAPET- connecting strips 310mm		2	120x18	215
BS-1	DACHBLENDEN- Blendenstützen - PARAPET- Parapet support 44x65		10	44x65	150
MB-1	DACHBLENDEN- Montagebrett - PARAPET- mounting board 226mm		22	58x18	215
T4-1	TRAUFENLEISTE - EAVES STRIPS 40x18			40x18	13.0 lfm/rm
SP5-1	STÜTZPFOSTE - SUPPORT POST 70x70		1	70x70	2300
SP5-2	STÜTZPFOSTE - SUPPORT POST 70x70		1	70x70	2360
A28-1	ADAPTER 120x66 Obere seite		1	120x66	2185
SH	SCHLAGHÖLZER - MOUNTING PIECES		3		
SR21	SCHRAUBEN - SCREWS 6.0x140 (ASSY, für Dachbalken - for roof beams)		6		
VP1	Verstellbare Pfostenstütze - Adjustable post support M10		2		
	FENSTER/WINDOW 915x420 A42-15K		1	A42-15K 3mm Echtglas / 3mm clear glass	
	TÜR/DOOR 1425x1955 TU11-GH DIN rechts, right handed		1	TU11-GH 3mm Echtglas / 3mm clear glass	
	✓ - Bitte selber anpassen (falls nötig)! / Cut into length on site (if needed)!				
Kood	Diederick 275x375+375_28 Materjal		File	Diederick 275x375+375_28.dwg 2/3	

Pärlinite ühendamine / Verbinden der Pfetten / Connecting purlins

1

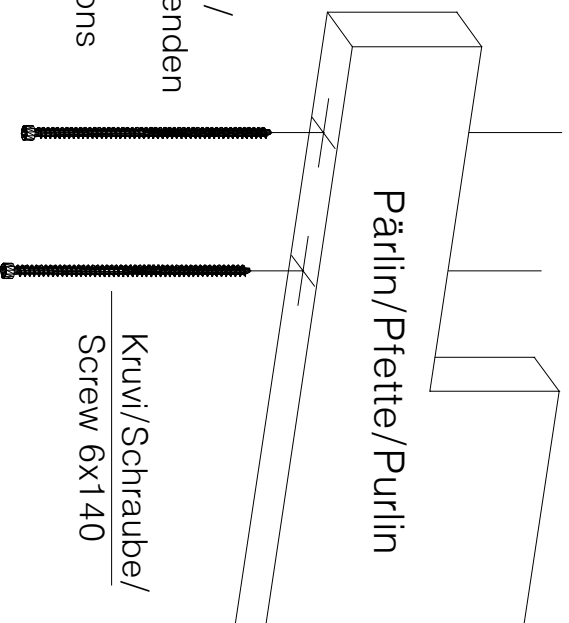
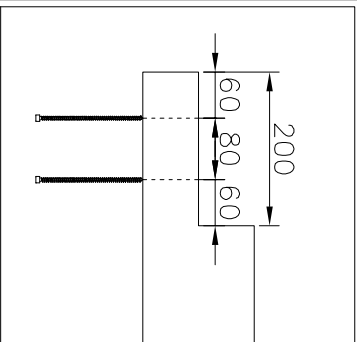

Märkige kruvide asukohad /
Markieren Sie die empfehlenden
Schraubenpositionen /
Mark the suggested positions
for screws

2

Keerake kruvid poole ulatuses sisse.
(Vaja läheb Assy AW30 või Torx T30 otsikut) ☆
Drehen Sie die Schrauben bis zur Hälfte
seiner Länge ein.

(Für diese Schrauben benötigen Sie einen
Assy AW30 oder Inrentorx T30
Schraubereinsatz) ☆

Turn the screws up
until the first half.

(These screws require Assy AW30
or Torx T30 driver bit) ☆

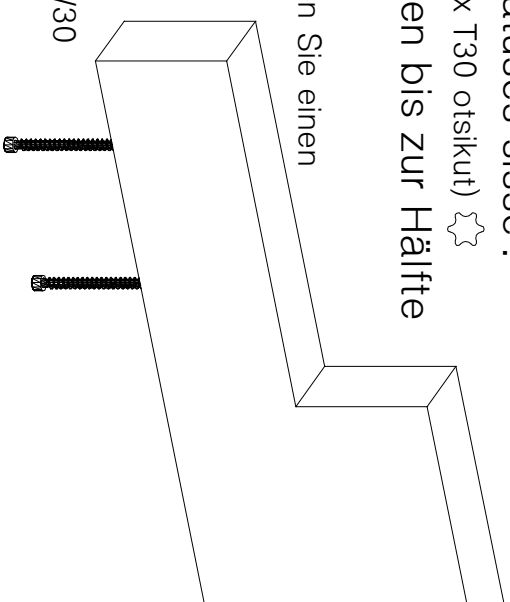

3

Hoja ühendatavad pärlinid tihedalt koos /
Setzen Sie die Enden der Balken zusammen /
Keep purlins tight together

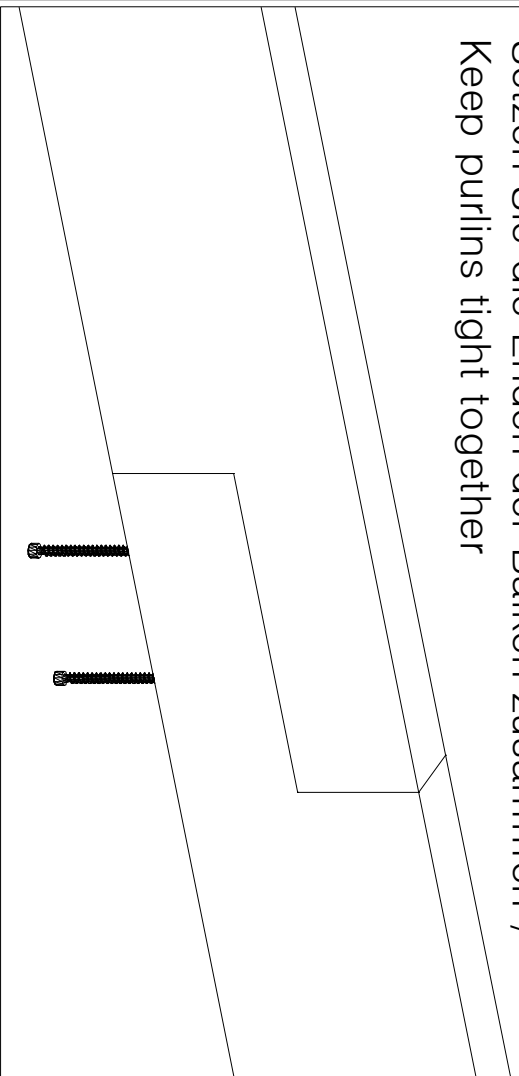

4

Keera kruvid lõpuni sisse /
Drehen Sie die Schrauben dann ganz ein /
Turn the screws up until the end

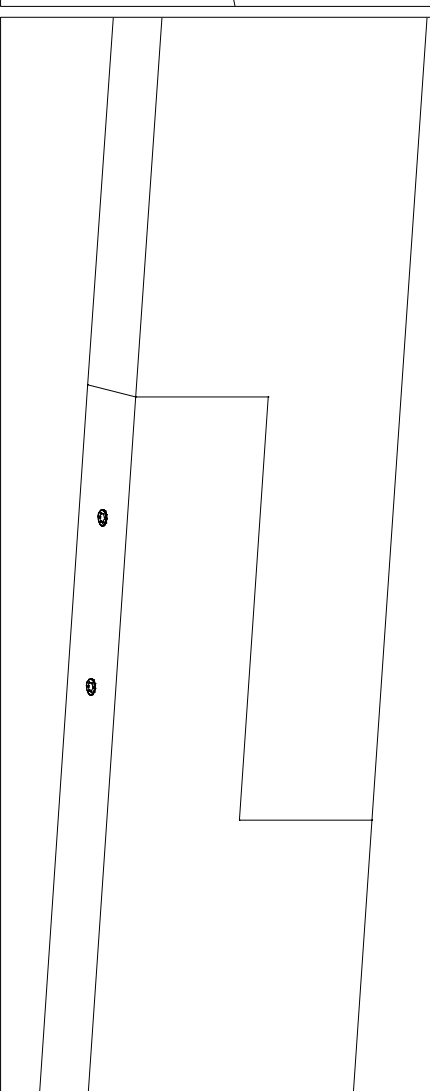

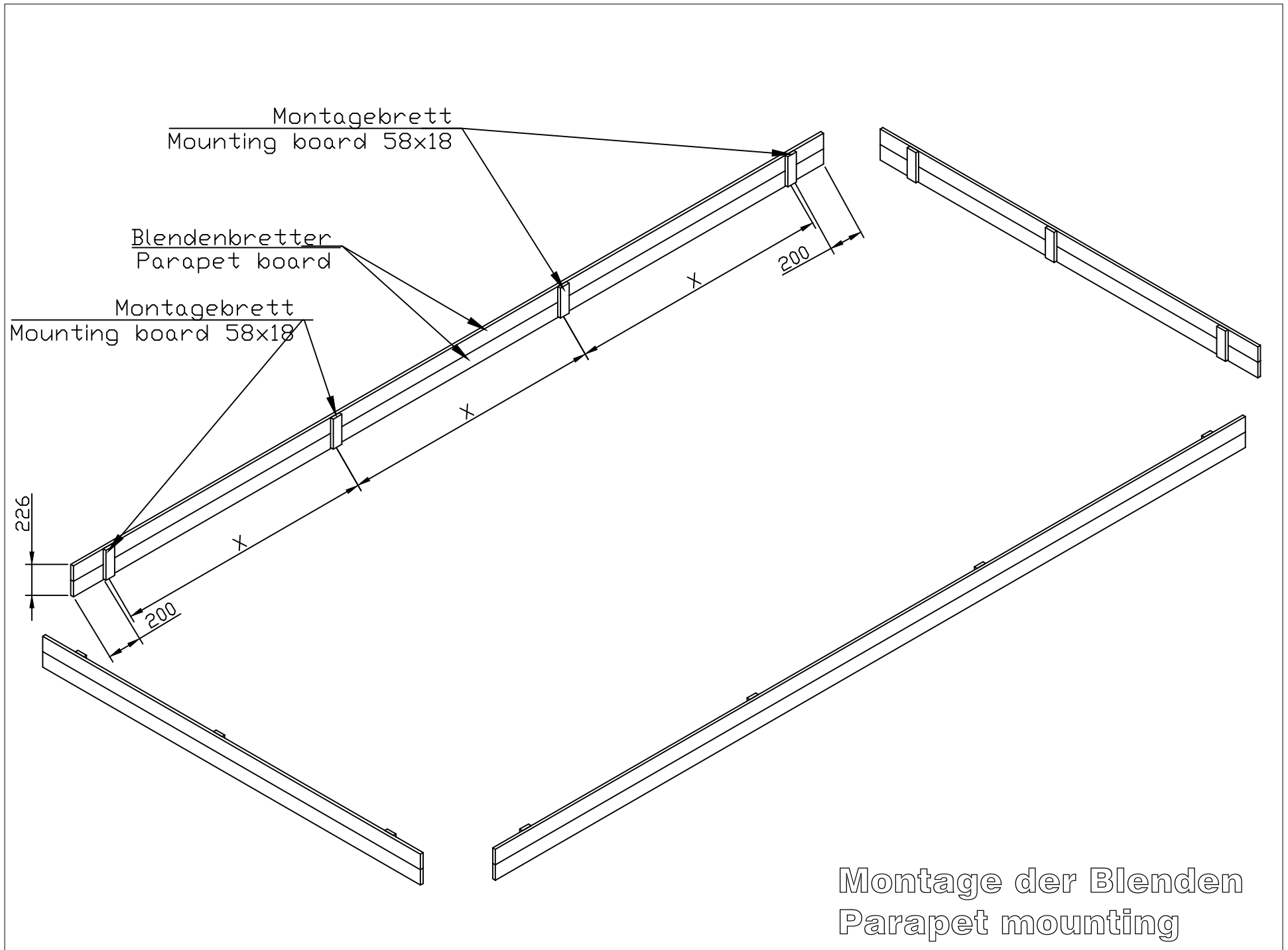

Montage der Blenden
Parapet mounting

Cutting support post / Schneiden der Stützpfosten



* Adjustment space for post support should be at least 50mm.

* Einstellraum für die Pfostenstütze muss mindestens 50mm sein.

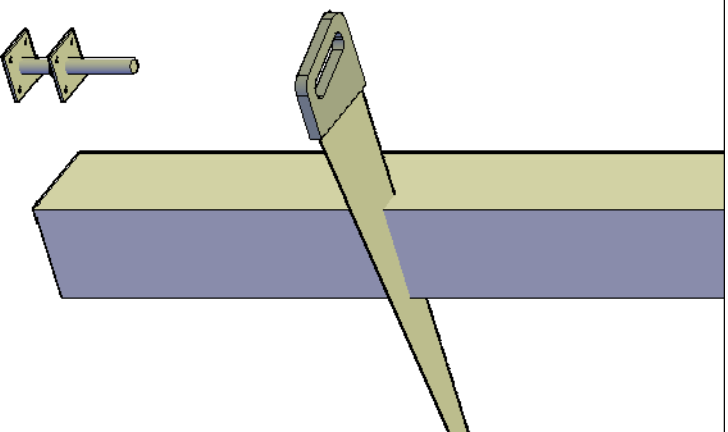

* Support post has extra length for various conditions. Must be sawn to suitable length on spot considering local conditions.

* Stützpfosten hat extra Länge für verschiedene Bedingungen. Muss vor Ort unter Berücksichtigung der örtlichen Gegebenheiten zu einer geeigneten Länge gesägt werden.

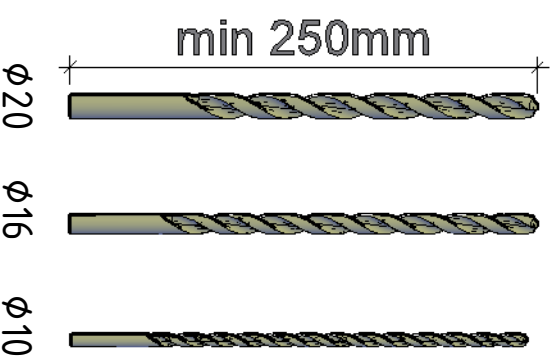
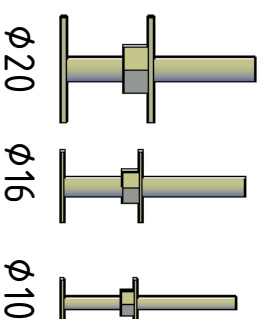

* In some cases you need to drill a new hole for a post support. Find a matching drill bit.

* In einigen Fällen müssen Sie ein neues Loch für die Pfostenstütze bohren. Finden Sie hier den passenden Bohrer.

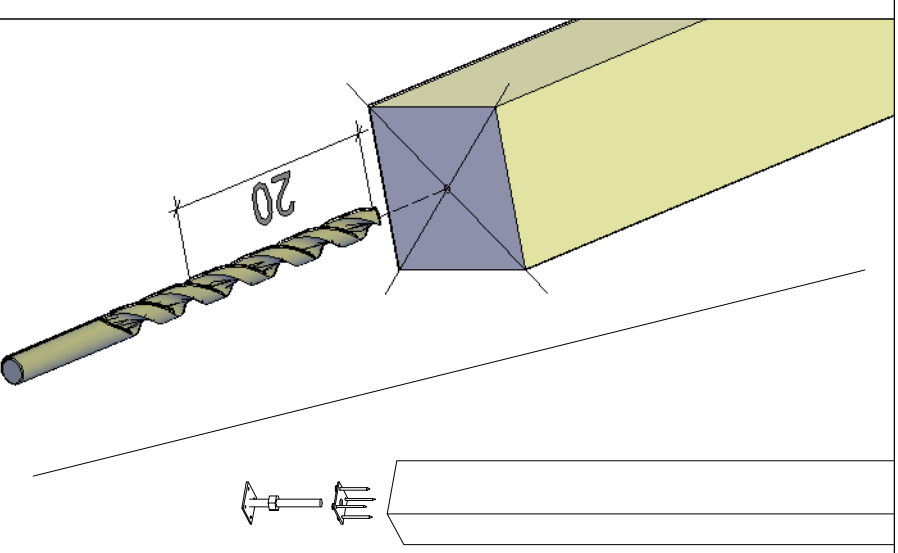

* Mark the center of the post and drill a new 20cm deep hole.

* Markieren Sie die Mitte des Pfostens und bohren Sie ein neues 20cm tiefes Loch. Danach mit Aufbau weiter machen.

Ukse montaa 0 / Tür montage / Door assembly
(GH+ / SH)

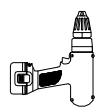
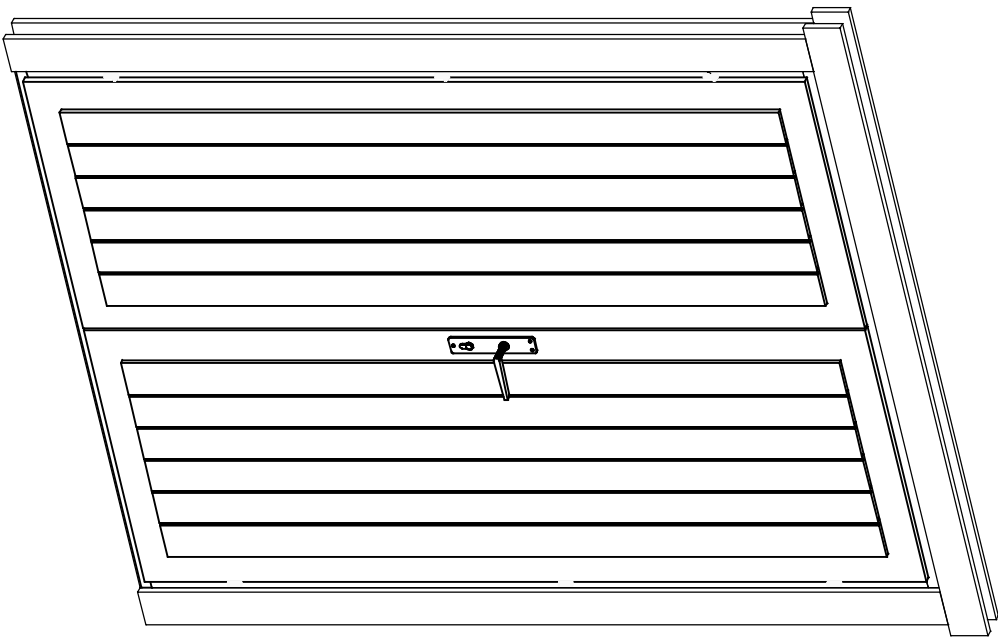

4.5x90

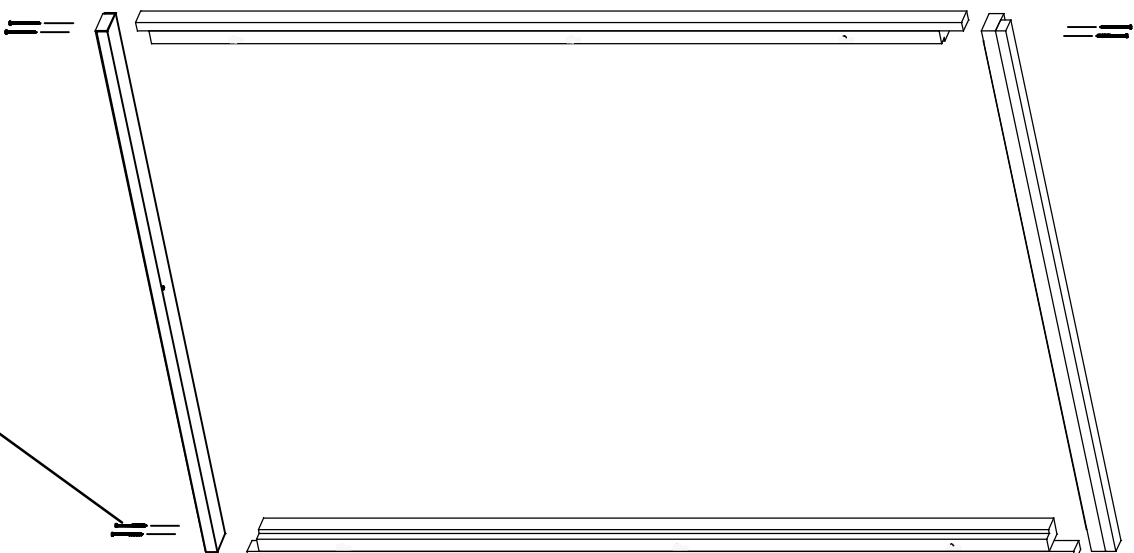

4.5x90



3.5x45

